

Service manual GS1-ED 60/40 230V/50Hz

Version: 2.01

Ident:

Series:

Pert-Number: 0600_A

This part can be ordered.

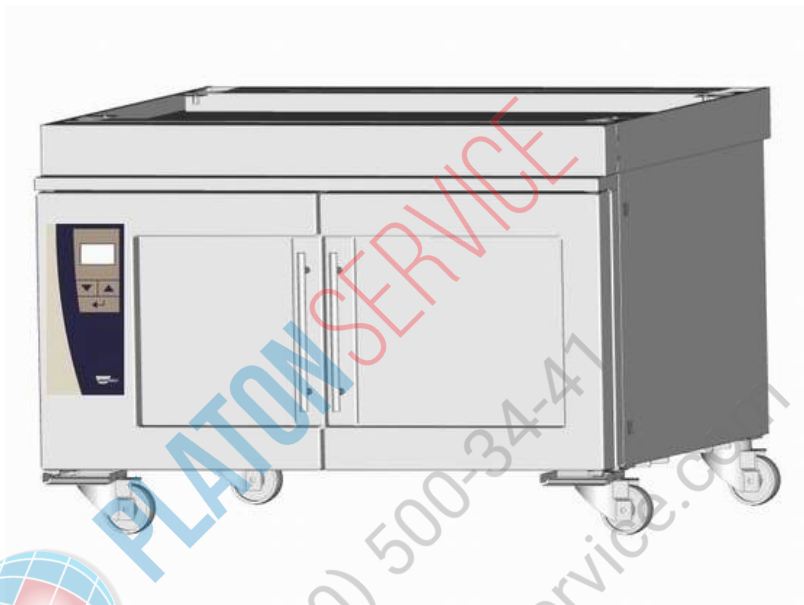

Chapter



105575 - climate control IS100 GS1-ED 60/40 230V/50Hz - V:
door complete GS1-ED 60/40 230V/50Hz - V:
frame GS1-ED 60/40 230V/50Hz - V:
102552 - tray runners Prover1-ED complete (2x5) GS1-ED 60/40 230V/50Hz - V:
water-energy-unit Prover 64 M - V:2.01

Service manual clime control IS100 GS1-ED 60/40 230V/50Hz

Version:

Ident:

Series:

Pert-Number: 105575

This part can be ordered.



Chapter

105575 - IS control 100



PLATON SERVICE
8 (800) 500 34-47
www.platonservice.com

Part: IS control 100

Pert-Number: 105575

To avoid moisture admittance from the operating side the display and the frame of the oven are water proofed and sealed. Please advise your customer that the control and the display of the oven should only be cleaned with a soft dry cloth.



PLATON SERVICE
8 (800) 500-34-44
www.platonservice.com

Service manual door complete GS1-ED 60/40 230V/50Hz

Version:

Ident:

Series:

Pert-Number:

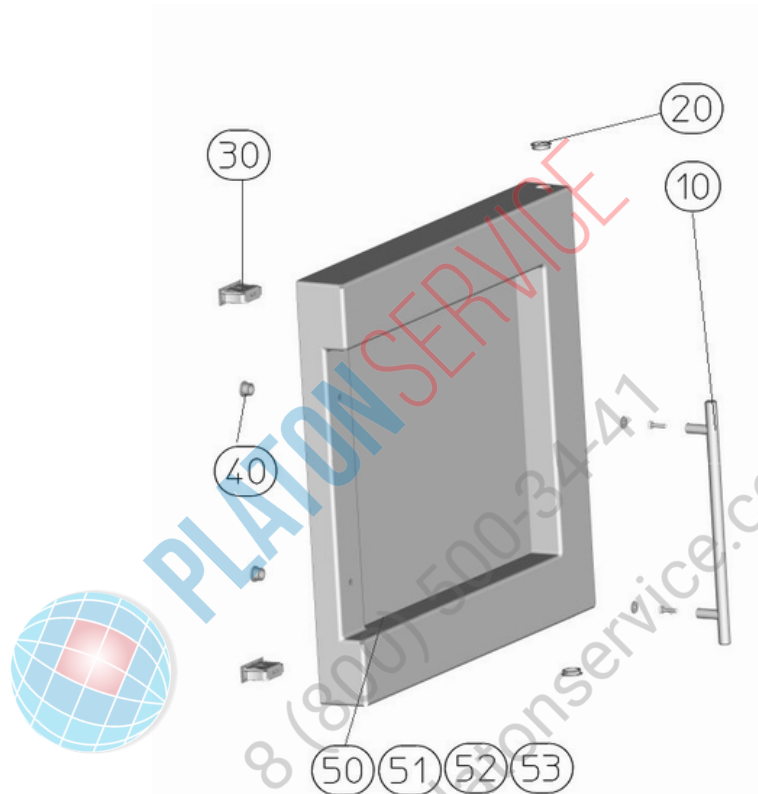

Chapter

- [010] - 102809 - door handle GS10/GS1-ED
- [020] - 102812 - bush bearing
- [030] - 102807 - vice action latch (door)
- [040] - 34297 - plug (door)
- [050] - 105136 - Door, left GS1-ED
- [051] - 105134 - Door, left with cutout GS1-ED
- [052] - 105137 - Door right GS1-ED
- [053] - 105135 - Door right with cutout GS1-ED

Part: door handle GS10/GS1-ED

Pert-Number: 102809

To prevent damage ensure that both door handles are securely fastened. The door handle is secured with screw M4X10 article number 42392 and washer article number 42209. Additionally the handle is secured with Locite 243 article number 61905.



Part: bush bearing

Pert-Number: 102812

To ensure the proofer door opens and closes properly check the door bearings.



Part: vice action latch (door)

Pert-Number: 102807

If the door lock needs to be re set. loosen the screws around the door latch. Thanks to the slotted holes the door can be easily adjusted. Only a correctly aligned door can guarantee the necessary door seal which results in optimal proofing.



Part: plug (door)

Pert-Number: 34297



Part: Door, left GS1-ED

Pert-Number: 105136

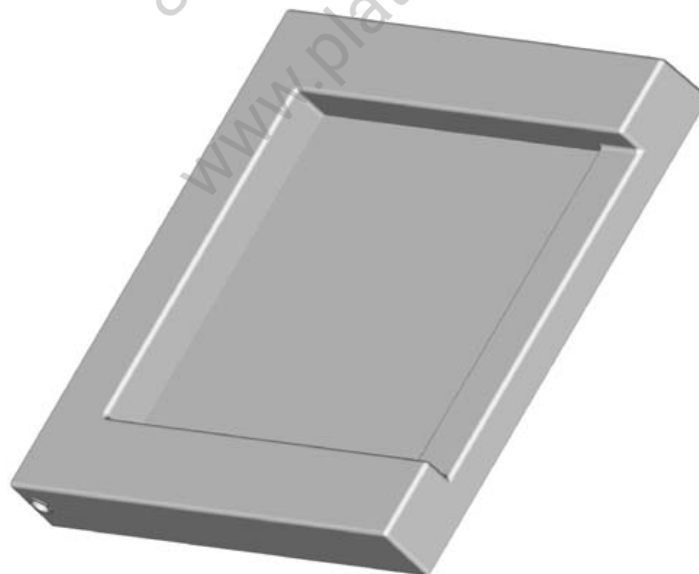

Part: Door, left with cutout GS1-ED

Pert-Number: 105134

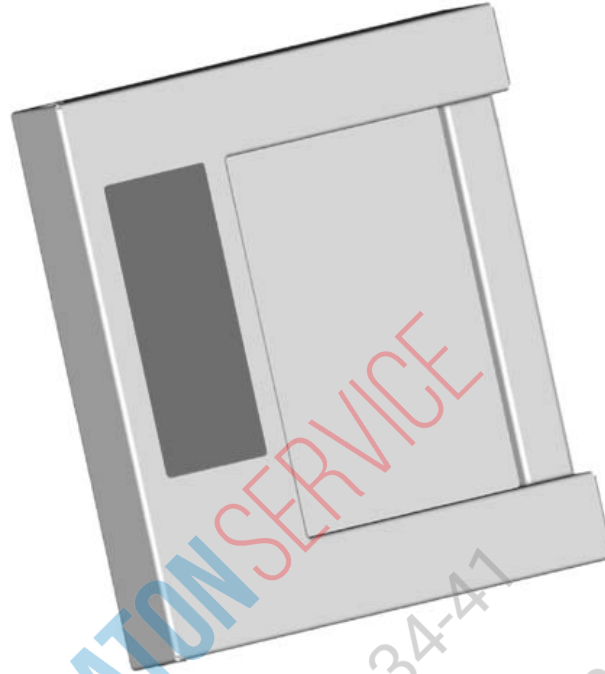

Part: Door right GS1-ED

Pert-Number: 105137

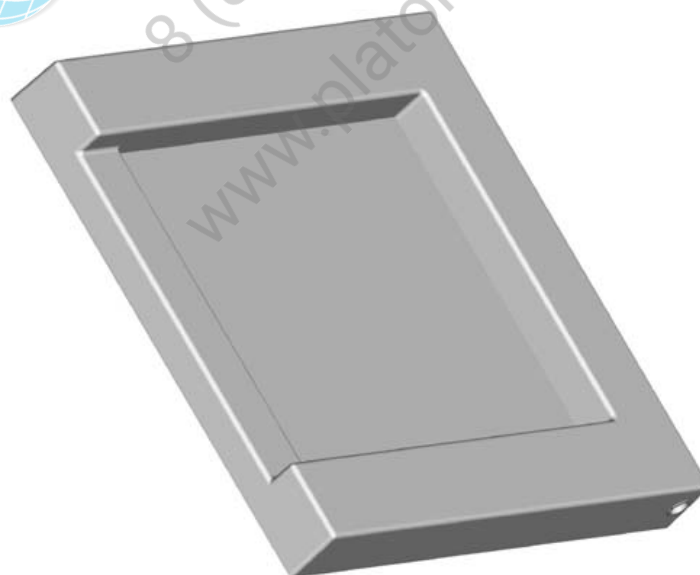

Part: Door right with cutout GS1-ED

Pert-Number: 105135

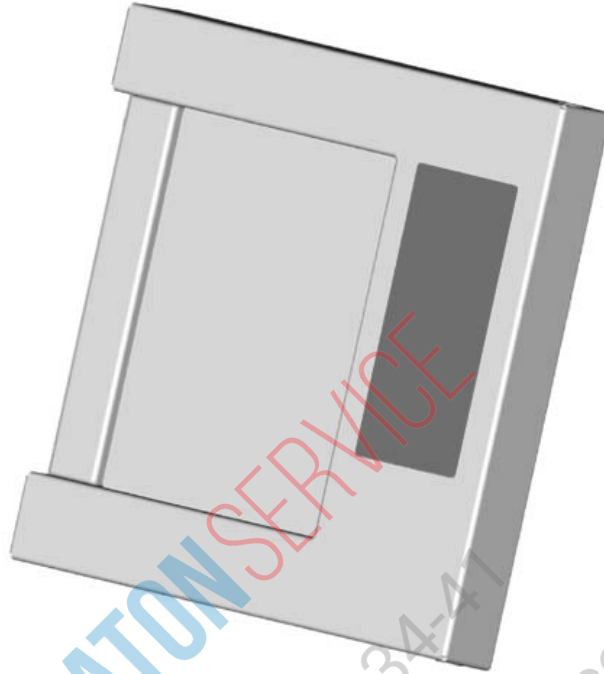

PLATON SERVICE
8 (800) 500-34-47
www.platonservice.com

Service manual frame GS1-ED 60/40 230V/50Hz

Version:

Ident:

Series:

Pert-Number:

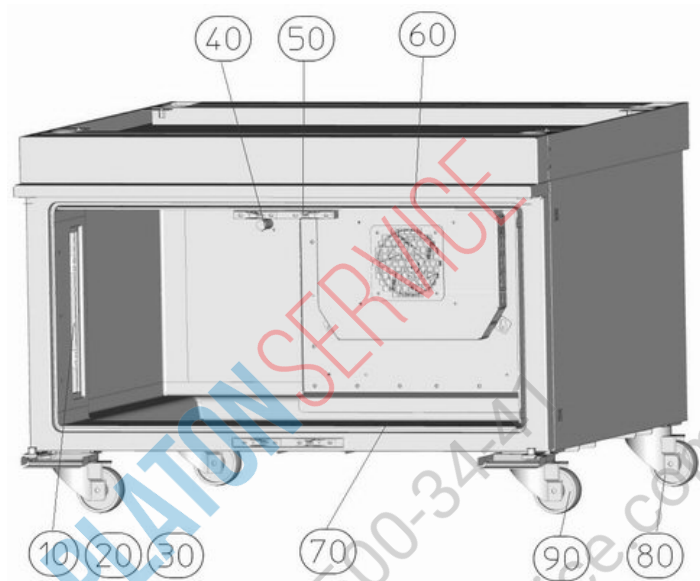

Chapter

- [010] - 102567 - halogen socket
- [020] - 101731 - halogen lamp 12V 10W
- [030] - 33042 - porcelain clamp 2-pole 10A
- [040] - 105669 - dual probe
- [050] - 102807 - vice action latch (door)
- [060] - 38605 - door seal
- [070] - 36149 - plug for water tray
- [080] - 9050-110-002 - castor
- [090] - 9050-110-001 - castor with brakes

Part: halogen socket

Pert-Number: 102567

Check the porcelain lamp holders and cables for damage. Please do not squeeze or kink the cable.



Part: halogen lamp 12V 10W

Pert-Number: 101731

When changing the halogen lamps please make sure that the lamps do not come in contact with hand sweat. Hand sweat will burn into the glass bulb and reduces the life of the halogen lamp. Please use the appropriate gloves.



Part: porcelain clamp 2-pole 10A

Pert-Number: 33042

Check the porcelain lamp holders and cables for damage. Please do not squeeze or kink the cable.



Part: dual probe

Pert-Number: 105669

The combi sensor measures the moisture and proofer chamber temperature. When installing make sure the slits are always facing down so that moisture will not settle on the measuring points giving off wrong readings.



Part: vice action latch (door)

Pert-Number: 102807

If the door lock needs to be re set. loosen the screws around the door latch. Thanks to the slotted holes the door can be easily adjusted. Only a correctly aligned door can guarantee the necessary door seal which results in optimal proofing.



Part: door seal

Pert-Number: 38605

The door seal is glued with transparent heat resistant silicone (order number 60375) around the radii on the corners and long distances in between. Should the door seal be exchanged then all the silicone must be removed by using a knife. Clean the door tracks and any silicone particles. Make sure when placing the new seal that it is completely in the frame. The seal needs to be pressed around the connecting piece on the top and bottom and in front of the oven with a broach so that it can "breathe". The door seal is a spare part and can be ordered under the number 38605.



Part: plug for water tray

Pert-Number: 36149

The plug in the water tub seals the cleaning opening of the proofer. To maintain an optimal climate in the proofer it is necessary to make sure that the plug is always closed when operating the proofer.



Part: castor

Pert-Number: 9050-110-002

To allow a simple driving out for maintenance, the wheels should be positioned in the direction of motion so that the wheels do not get stuck.



Part: castor with brakes

Pert-Number: 9050-110-001

To allow a simple driving out for maintenance, the wheels should be positioned in the direction of motion so that the wheels do not get stuck.



Service manual

tray runners Prover1-ED complete (2x5) GS1-ED 60/40 230V/50Hz

Version:

Ident:

Series:

Pert-Number: 102552

This part can be ordered.

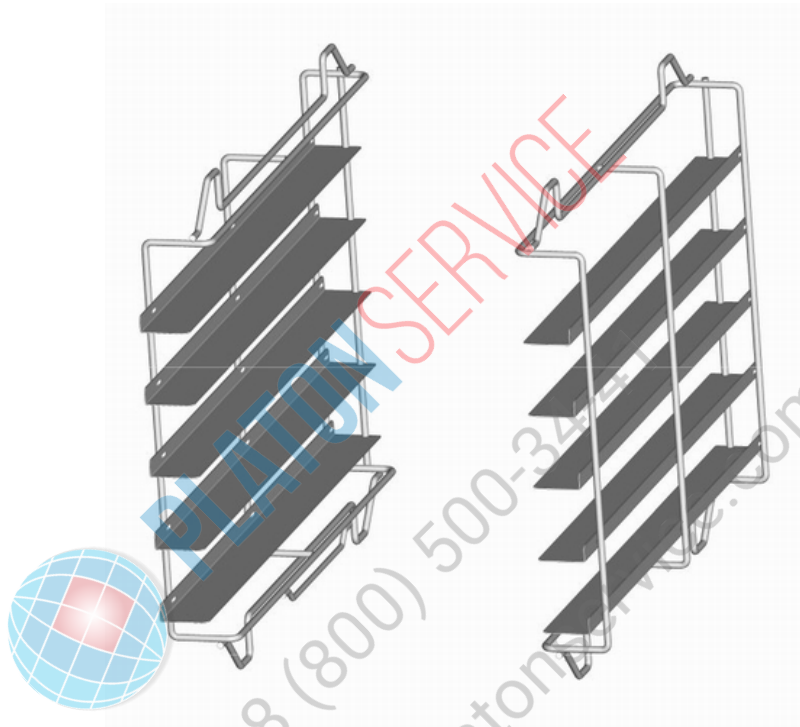

Chapter

- [001] - 102552 - tray runners GS1-ED complete (2x5)
- [010] - 103026 - tray runners GS-ED, 5 trays left
- [020] - 103027 - tray runners GS-ED, 5 trays right

Part: tray runners GS1-ED complete (2x5)

Pert-Number: 102552

Part: tray runners GS-ED, 5 trays left

Pert-Number: 103026

To remove the racks, lift the bottom of the rack upwards, over the plastic securing brackets and pull out sideways. To insert the racks, hook them into the top plastic fasteners first and then affix them to the bottom plastic fasteners.

Part: tray runners GS-ED, 5 trays right

Pert-Number: 103027

To remove the racks, lift the bottom of the rack upwards, over the plastic securing brackets and pull out sideways. To insert the racks, hook them into the top plastic fasteners first and then affix them to the bottom plastic fasteners.



PLATON SERVICE
8 (800) 500-34-41
www.platonservice.com

Service manual water-energy-unit Prover 64 M

Version: 2.01

Ident:

Series:

Pert-Number:

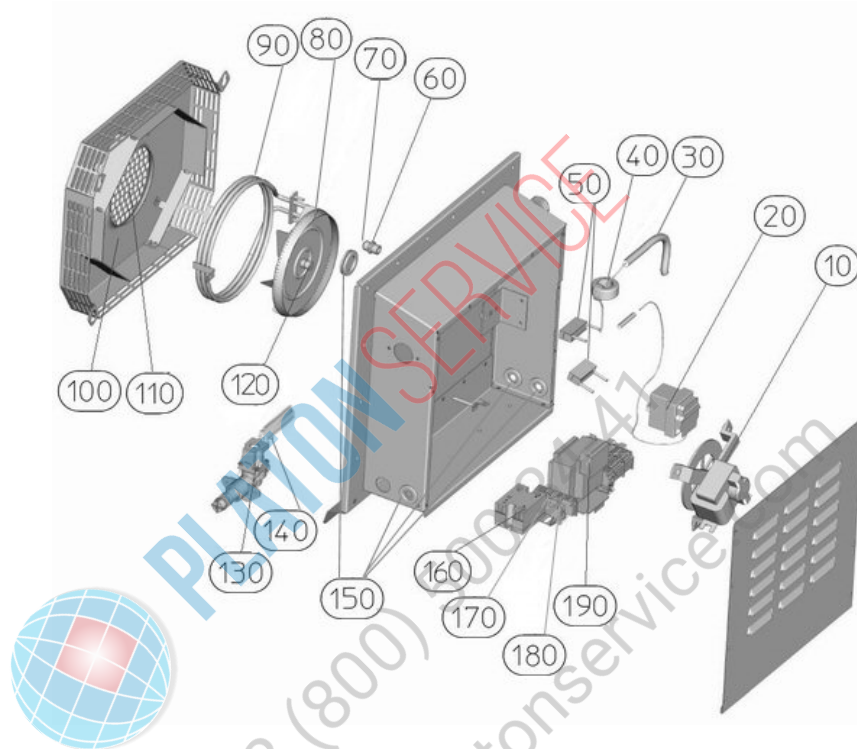

Chapter

- 104476 - hose 3/4"
- X0700-300-001 - water-energy-unit standard
- X0700-300-002 - water-energy-unit Prover-ED heated glass
- 33372 - suppressor element
- [010] - 36106 - motor
- [020] - 102696 - safety limit switch
- [030] - 37804 - cable connection 3,0m/3G 1,5/Schuko/230V
- [040] - 36583 - ferrite core R3615X
- [050] - 105726 - condenser
- [060] - 102530 - screwing
- [070] - 107992 - sealing ring Cu 13x18
- [080] - 105391 - vaporizer
- [090] - 103551 - heating 2000 W
- [100] - 105388 - ventilation cover
- [110] - 105786 - fan grill
- [120] - 103339 - adjusting collar with grub screw
- [130] - 103550 - solenoid valve
- [140] - 33524 - HT - hose silicone D 18xS3 LW12
- [150] - 38525 - nozzle to lead the diaphragm through
- [160] - 34912 - semi-conductor relay 1-pole
- [170] - 34752 - micro-fuse 1A
- [170] - 34753 - micro-fuse 0,5A 5x20
- [180] - 34108 - clamp grey 3L 2.5qmm
- [180] - 34109 - clamp 3L blue 280-684
- [180] - 34110 - clamp 3L 2.5qmm 280-687
- [190] - 100840 - transformer
- [190] - 9030-600-001 - transformer 12V/24V/40V (heated glass)

Part: hose 3/4"

Pert-Number: 104476

Water supply hose 3/4". Inform your customer that the water supply should only be open when the oven is in use. In this manner you can avoid damage.



Part: water-energy-unit standard

Pert-Number: X0700-300-001

Part: water-energy-unit Prover-ED heated glass

Pert-Number: X0700-300-002

Part: suppressor element

Pert-Number: 33372

The suppressor element covers the solenoid valve. The prevents EMV disturbances to other compnents in the net.



Part: motor

Pert-Number: 36106

For improved baking results the Hanning Motor has two rotating directions and several speeds. In ovens with the IS Control the speed is regulated by the Triac setter. In ovens with a manual control the contactor regulates the speed. The motor is secured with 4 M 6 nuts. The distance sleeves screws that are fixed by locknuts must always have the same height. Tighten the nuts diagonally to avoid tension. The motor has a built in thermo protection (bimetal) that activates at 160° C and automatically resets when cooled down. When the motor protection is activated the motor function is interrupted.



Part: safety limit switch

Pert-Number: 102696

After transportation of the appliance please note that the safety temperature limiter (STB) automatically releases with temperatures under +8°C. To allow the appliance to acclimatize let it stand for 30 minutes at room temperature before re-setting the STB. The STB can be re-set as often as needed. Please note that the STB does not activate without reason ! Insulate the capillary tube (e.g. on the circuit board) on its critical spots with silicone hose Article number 40074.



Part: cable connection 3,0m/3G 1,5/Schuko/230V

Pert-Number: 37804

Part: ferrite core R3615X

Pert-Number: 36583

Part: condenser

Pert-Number: 105726

Part: screwing

Pert-Number: 102530



Part: sealing ring Cu 13x18

Pert-Number: 107992

Part: vaporizer

Pert-Number: 105391

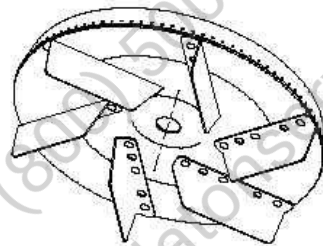

Part: heating 2000 W

Pert-Number: 103551

We recommend when installing the heater the securing screws are non-threading. Please make sure the heater is correctly situated so that the securing attachments fit through the fan wheel to be connected.



Part: ventilation cover

Pert-Number: 105388

Make sure at the end of working with the proofer that the fan cover and safety guard are correctly fastened otherwise there is a risk of injury.

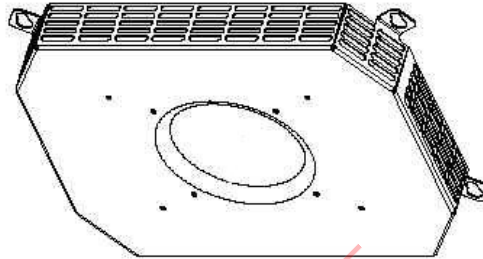

Part: fan grill

Pert-Number: 105786

Make sure at the end of working with the proofer that the fan cover and safety guard are correctly fastened otherwise there is a risk of injury.

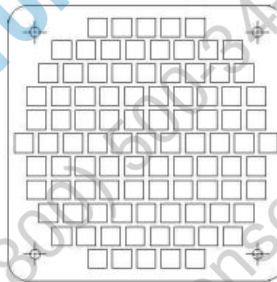

Part: adjusting collar with grub screw

Pert-Number: 103339

The middle of the adjusting ring for the rotation sprayer of the motor axel. Please read the installation instructions of the rotation sprayer.



Part: solenoid valve

Pert-Number: 103550

It is necessary to clean the dirt sieve of the solenoid valve regularly. Particles in the water line will stick to the sieve and interrupt the water flow. Please note the maximum water pressure and other warnings from the data sheets regarding the water connection. The solenoid valve is a valve for the steaming filler as well as for the automatic cleaning process Pro Clean. The solenoid valve works with a flow pressure of 150 - 600 kPa. You can test the solenoid valve function in the PC - Tool - Test. Attention the test is a continued test and this function is not protected from overload.



Part: HT - hose silicone D 18xS3 LW12

Pert-Number: 33524



Part: nozzle to lead the diaphragm through

Pert-Number: 38525

To reset the safety temperature limit switch the fan cover which is found in the interior of the proofer must be removed. The knob is protected from spray and steam under a membrane case. By firmly pressing the covered key the safety temperature limit can be re-set. Please note that the STB does not activate without reason!



Part: semi-conductor relay 1-pole

Pert-Number: 34912

The solid state relay controls the heater. Depending on the temperature this will automatically switch it on or off. (type can vary)



Part: micro-fuse 1A

Pert-Number: 34752



Part: micro-fuse 0,5A 5x20

Pert-Number: 34753



Part: clamp grey 3L 2.5qmm

Pert-Number: 34108

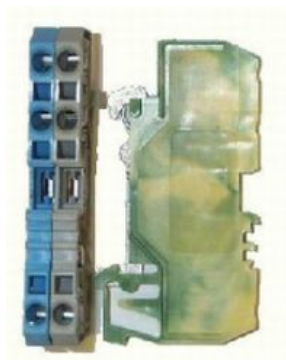

Part: clamp 3L blue 280-684

Pert-Number: 34109



Part: clamp 3L 2.5qmm 280-687

Pert-Number: 34110



Part: transformer

Pert-Number: 100840

The lighting transformer provides power to the baking chamber. The interior lighting is (2x12V/20W) Please note the wiring when removing/inserting. The wire should not come in contact with the circuit board. This may cause sporadic interference with the electronics.



Part: transformer 12V/24V/40V (heated glass)

Pert-Number: 9030-600-001





PLATONSERVICE

8 (800) 500-34-47

www.platonservice.com

Copyright:

WIESHEU GmbH retains the copyright for this service manual.
This service manual is solely intended for authorised service partners and their personnel.
It contains instructions and information which may not be copied, distributed or otherwise imparted as a whole or in part.

All representations, drawings, images, texts and details are protected by copyright.
They are subject to industrial property rights.

About this service manual:

All figures in this document have the purpose of aiding comprehension. The figures are not to scale. In some cases the figures are similar to the original product and may differ slightly.

Important!

Prevent malfunctions or damage caused by wrong spare parts.
We recommend the sole use of WIESHEU original spare parts.

Wiesheu GmbH
Daimlerstraße 10
DE-71563 Affalterbach
Phone: +49 (0)7144 / 3 03-0
Fax: +49 (0)7144 / 3 03-11
Email: info@wiesheu.de
www.wiesheu.de

Rev.: 10/11/2011



PLATON SERVICE

8 (800) 500-34-41

www.platonservice.com